

MOBICOOL

Our Name is our Mission

T35 W35



Thermoelectric cooler
Instruction Manual

T35/W35

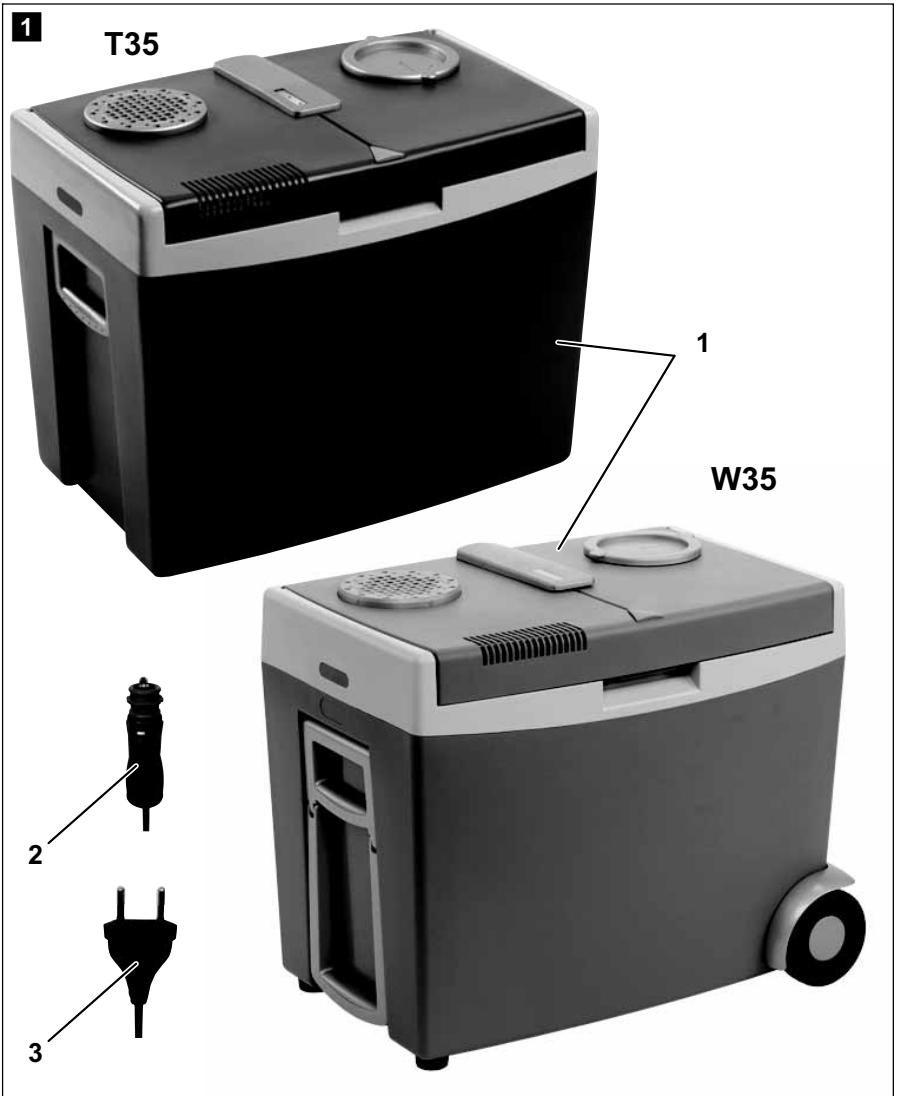

2

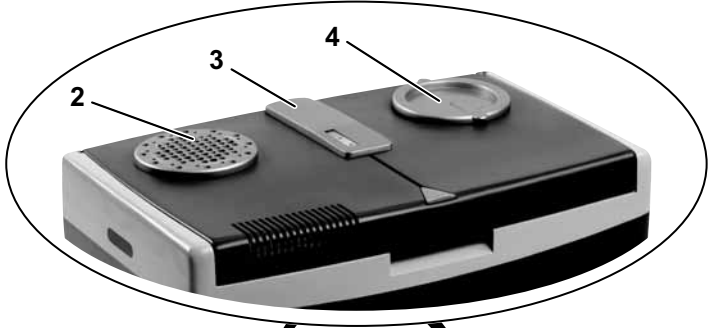

T35

W35

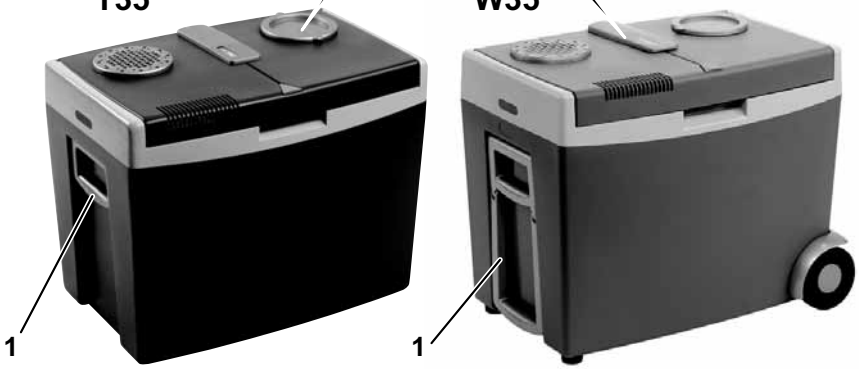

3

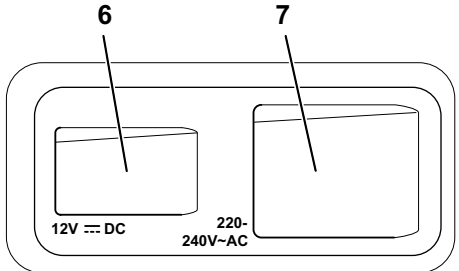
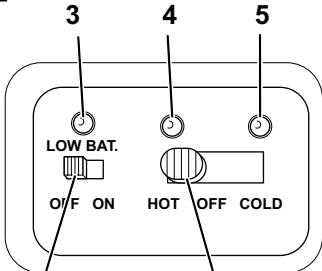

T35/W35

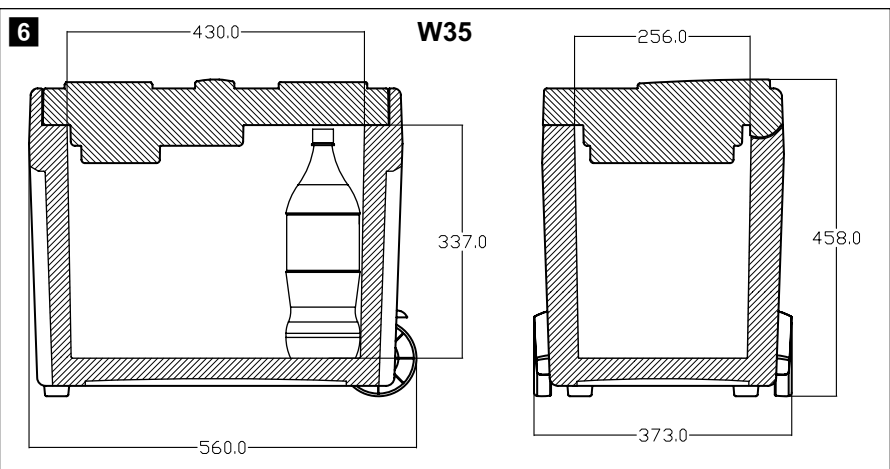
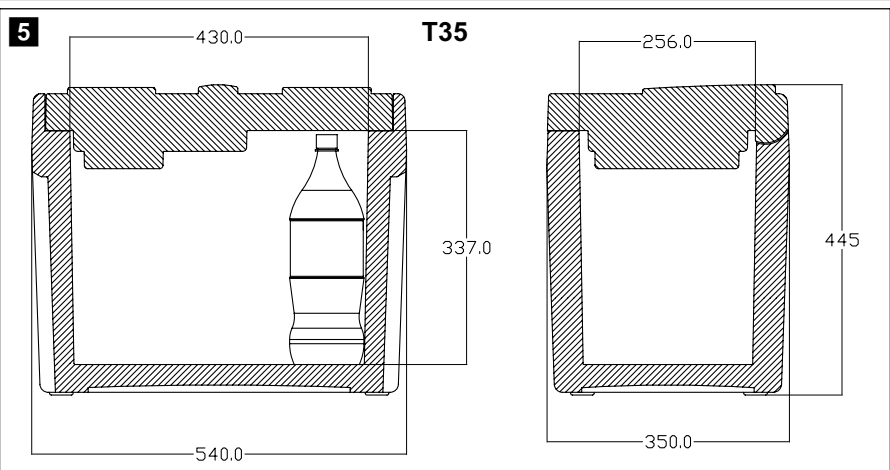
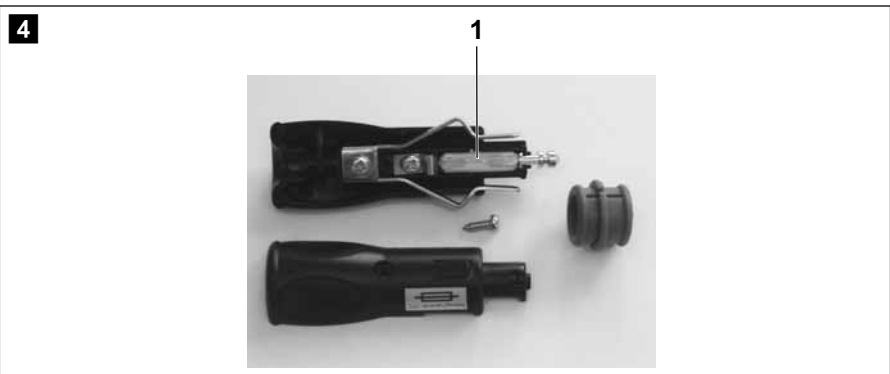

Please read this operating manual carefully before starting the device. Keep it in a safe place for future reference. If the device is resold, this operating manual must be handed over to the purchaser along with it.

Contents

1	Safety instructions	6
2	Intended use	8
3	Scope of delivery	9
4	Technical description	9
5	Operation	10
6	Cleaning and maintenance	13
7	Troubleshooting	13
8	Disposal	14
9	Technical data	14

Please observe the following safety instructions.

1 Safety instructions

1.1 General safety



- Do not operate the device if it is visibly damaged.
- Ensure that the ventilation slots are not covered.
- This device may only be repaired by qualified personnel. Inadequate repairs can lead to considerable hazards.
- Persons (including children) whose physical, sensory or mental capabilities or lack of experience and knowledge prevents them from using the appliance safely should not use this appliance without initial supervision or instruction by a responsible person.
- **Electronic devices are not toys.**
Always keep and use the device out of the reach of children.
- Children must be supervised to ensure that they do not play with the device.
- Food may only be stored in its original packaging or in suitable containers.
- The cooling device is not suitable for transporting caustic materials or materials containing solvents.



- Only connect the device as follows:
 - With the cable supplied (fig. **1** 2, page 3) to the cigarette lighter in the vehicle or a 12 V plug socket in the vehicle
 - Or with the cable supplied (fig. **1** 2, page 3) to the cigarette lighter in the vehicle or a 24 V plug socket in the vehicle (**only for 12/24**)
 - Or with the connection cable supplied (fig. **1** 3, page 3) to the 220–240 V AC mains supply (**only for DC/AC**).
- Do not pull the plug out of the 12 V, 24 V or 220–240 V socket by the cable.
- If the connection cable is damaged, it must be replaced with the cable of the same type and specifications.
- Pull out the connection cable:
 - Before cleaning and maintenance
 - After use
- On boats: if the device is powered by the mains, ensure that the power supply has a ground fault interrupter circuit. **Danger of fatal injuries!**
- Disconnect the cooling device and other power consuming devices from the battery before connecting the quick charging device.
- Check that the voltage specification on the type plate corresponds to that of the energy supply.

1.2 Operating the device safely

- Before starting the device, ensure that the power supply line and the plug are dry.
- Do not place the device near naked flames or other heat sources (heaters, direct sunlight, gas ovens etc.).
- **Caution! Danger of overheating!**
Ensure at all times that there is sufficient ventilation so that the heat that arises during operation does not build up. Make sure that the device is sufficiently far away from walls and other objects so that the air can circulate.
- Do not fill the inner container with ice or fluid.
- Never immerse the device in water.
- Protect the device and the cable against heat and moisture.

- Do not touch exposed cables with your bare hands. This especially applies when operating the device with an AC mains power supply. **Danger of fatal injuries!**
- Mobicool cannot be held liable for damage resulting from **improper usage** or **incorrect operation**.

2 Intended use

The cooling device is suitable for cooling and warming foodstuffs. There is a switch to change between heating and cooling modes.

The device is designed for operation on:

- A 12 V DC vehicle-electrics socket of a car (cigarette lighter), boat or caravan.
- A 24 V DC vehicle-electrics socket of a car (cigarette lighter), boat or caravan (**12/24 V version only**).
- A 220–240-V AC mains supply (**DC/AC version only**)

The appliance may also be used for camping use. The appliance shall not to be exposed to rain. The appliance shall not to be exposed to rain. It can be used as a box or cupboard.



Caution!

If you wish to cool medicines, please check if the cooling capacity of the device is suitable for the medicine in question.

An integrated battery monitor can be switched on to protect your vehicle battery from discharging to dangerously low levels (see “Using the battery monitor” on page 12).

3 Scope of delivery

No. in fig. 1 , page 3	Quantity	Description
1	1	Cooling device T35 DC, T35 12/24, T35 DC/AC W35 DC, W35 12/24, W35 DC/AC
2	1	DC version: Connection cable for 12 V DC connection 12/24-V version: cable for 12 V DC supply or 24 V DC supply
3	1	DC/AC version only: Connection cable for 220–240 V AC connection

4 Technical description

The cooler is suitable for mobile use. You can cool products to a maximum of 20 °C under the ambient temperature or warm them to a maximum of 65 °C.

The device has an integrated mains adapter with a priority circuit. The device switches automatically to mains operation when the device is connected to a 220–240 V AC mains supply even if the 12 V or 24 V connection cable is still connected.

A grid divider can be used to separate foodstuffs, e.g. bottles and fruit. A single drinks bottle can be removed via the bottle hatch.

The **W35** has two wheels and a multi-function handle so that it can be pulled along. Alternatively, you can carry with two hands.

Its cooling system is a non-wearing and CFC-free Peltier cooling, the heat is discharged by a fan.

4.1 Description of the device

Your cooler consists of the following parts:

No. in fig. 2 , page 4	Description
1	Handle
2	Ventilation slots
3	Operating panel and connection sockets for voltage supply (fig. 3 , page 4)
4	Bottle hatch

5 Operation

The cooler is switched on and off via an operating panel with a cover (fig. **2** 3, page 4). The operating displays are visible at all times.



Note

Before starting your new cooling device for the first time, you should clean it inside and outside with a damp cloth for hygienic reasons (please also refer to the "Cleaning and maintenance" chapter on page 13).

5.1 Energy saving tips

- Choose a well ventilated installation location which is protected against direct sunlight.
- Allow warm food to cool down first before placing it in the device to keep cool.
- Do not open the cooling device more often than necessary.
- Remove individual drinks bottles through the bottle hatch (fig. **2** 4, page 4).
- Do not leave the lid or door open for longer than necessary.

5.2 Using the cooler



Note

Like every cooling device, your cooler must be properly ventilated so that any heat created can dissipate. Otherwise proper functioning cannot be ensured.

- Place the cooler on a firm base.

- Plug the 12 V connection cable (fig. **1** 2, page 3) in into the DC socket (fig. **1** 6, page 3) and connect it to the cigarette lighter or a 12 V plug socket in the vehicle.

or ...

- Plug the 24 V cord (fig. **1** 2, page 3) (**12/24-V version only**) into the DC socket (fig. **3** 6, page 4) and connect it to the cigarette lighter or a 24 V socket in the vehicle.

or ...

- Plug the 220–240 V connection cable (fig. **1** 3, page 3) (**only for DC/AC**) into the AC voltage socket (fig. **3** 7, page 4) and connect it to the 220–240 V AC mains supply.

Switch the battery monitor (fig. **3** 2, page 4) to “OFF”.

- Push the switch (fig. **3** 1, page 4) on the operating panel to “HOT” (Heating) or “COLD” (Cooling) to switch on the cooler.



Note

Close the box tightly by pushing down the lid.

- ✓ The indicators on the control panel show you the operating mode:

Operating display

Red (fig. **3** 4, page 4)

Green (fig. **3** 5, page 4)

Betriebsmodus

Warming

Cooling

- ✓ The cooler starts cooling/heating the interior.



Caution!

Ensure that the objects placed in the cooler are suitable for cooling/warming to the selected temperature.

- If you wish to switch the cooler off:
 - Slide the switch (fig. **3** 1, page 4) to the “OFF” position
 - Unplug the connection cable.

5.3 Using the battery monitor



Caution!

If you have connected your cooler to the 220–240 V AC mains supply, switch the battery monitor off.

The battery monitor protects your vehicle battery against discharging too much when the device is connected to the on-board 12 V or 24 V supply.

- Push the switch (fig. **3** 2, page 4) on the operating panel to “ON” to switch on the battery monitor.
- ✓ The red LED (fig. **3** 3, page 4) on the operating panel displays the status of the battery monitor:

Operating display

Operating mode

LED glows

The switch-on voltage (13.1 V ± 0.2 V) is available and the cooler is in operation.

LED flashes

The switch-off voltage (11.7 V ± 0.2 V) has been reached and the battery monitor has switched off the cooler.

- Push the switch (fig. **3** 2, page 4) on the operating panel to “OFF” to switch off the battery monitor.

5.4 Connecting to a cigarette lighter



Note

If you connect the device to the cigarette lighter of your vehicle, remember that the ignition must be turned on to supply the device with power.

6 Cleaning and maintenance



Caution!

Before cleaning the cooler, pull the cable out of the socket or the cigarette lighter.



Caution!

Do not clean the cooler under running water or in dish water.



Caution!

Do not use abrasive cleaning agents or hard objects during cleaning as these can damage the cooler.

- Occasionally clean the device interior and exterior with a damp cloth.

7 Troubleshooting

Fault	Possible cause	Suggested remedy
Your cooler does not function (plug is inserted, LED (fig. 3 4 or 5, page 4) does not glow).	There is no voltage present in the 12/24 V socket (cigarette lighter) in your vehicle.	The ignition must be switched on in most vehicles for voltage to flow at the cigarette lighter.
	No voltage present in the AC voltage socket.	Try using another plug socket.
Your cooler does not cool (plug is inserted, LED (fig. 3 5, page 4) glows).	The inner fan or the cooling element is defective.	This can only be repaired by an authorised customer services unit.
Your box does not heat (plug is inserted, LED (fig. 3 4, page 4) lights up).	The inner fan or the cooling element is defective.	This can only be repaired by an authorised customer services unit.
When operating from the 12/24 V socket (cigarette lighter): The ignition is on and the cooler is not working. Pull the plug out of the socket and make the following checks.	The fitting of the 12/24 V plug is dirty. This results in a poor electrical contact. The fuse of the 12/24 V plug has blown. The vehicle fuse has blown.	If the plug of your cooler becomes very warm in the 12/24 V socket fitting, either the fitting must be cleaned or the plug has not been assembled correctly. Replace the fuse (5 A) in the 12/24 V plug (fig. 4 1, page 5). Replace the vehicle's 12/24 V socket fuse (usually 15 A). Please refer to the operating manual of your vehicle.





8 Disposal

- Place the packaging material in the appropriate recycling waste bins wherever possible.







If you wish to finally dispose of the device, ask your local recycling centre or specialist dealer for details about how to do this in accordance with the applicable disposal regulations.





9 Technical data

	T35 DC	T35 12/24
Gross capacity:	35 litres	
Connection voltage:	12 V DC	12/24 V DC
Power consumption:	Cooling: 46 W Warming: 41 W	Cooling: 46 W Warming: 41 W
Cooling capacity:	Max. 20 °C under ambient temperature	
Heating capacity:	approx. 65 °C interior temperature (fixed-point thermostat)	
Weight:	approx. 7.8 kg	approx. 8.0 kg
Dimensions:	fig. 5, page 5	
Testing/certification:	    	

T35/W35

Technical data

	T35 DC/AC	W35 DC
Gross capacity:	35 litres	
Connection voltage:	12 V DC 220–240 V AC ~50 Hz	12 V DC
Power consumption:	DC: Cooling: 46 W DC: Warming: 41 W AC: Cooling: 45 W AC: Warming: 42 W	Cooling: 46 W Warming: 41 W
Cooling capacity:	Max. 20 °C under ambient temperature	
Heating capacity:	approx. 65 °C interior temperature (fixed-point thermostat)	
Weight:	approx. 8.1 kg	approx. 8.5 kg
Dimensions:	fig. 5 , page 5	fig. 6 , page 5
Testing/certification:	    	

	W35 12/24	W35 DC/AC
Gross capacity:	35 litres	
Connection voltage:	12/24 V DC	12 V DC 220–240 V AC ~50 Hz
Power consumption:	Cooling: 46 W Warming: 41 W	DC: Cooling: 46 W DC: Warming: 41 W AC: Cooling: 45 W AC: Warming: 42 W
Cooling capacity:	Max. 20 °C under ambient temperature	
Heating capacity:	approx. 65 °C interior temperature (fixed-point thermostat)	
Weight:	approx. 8,7 kg	approx. 8,8 kg
Dimensions:	fig. 6 , page 5	
Testing/certification:	    	

This device carries the GS symbol to indicate tested and proven safety.
Versions, technical modifications and delivery options reserved.



MGD Online
Unit 6 Flynn Row
Fenton Industrial Estate
Fenton
Stoke on Trent
Staffordshire
ST4 2SE

Freephone 0800 970 9486
www.mgdonline.co.uk